

CÉSAR

Collection

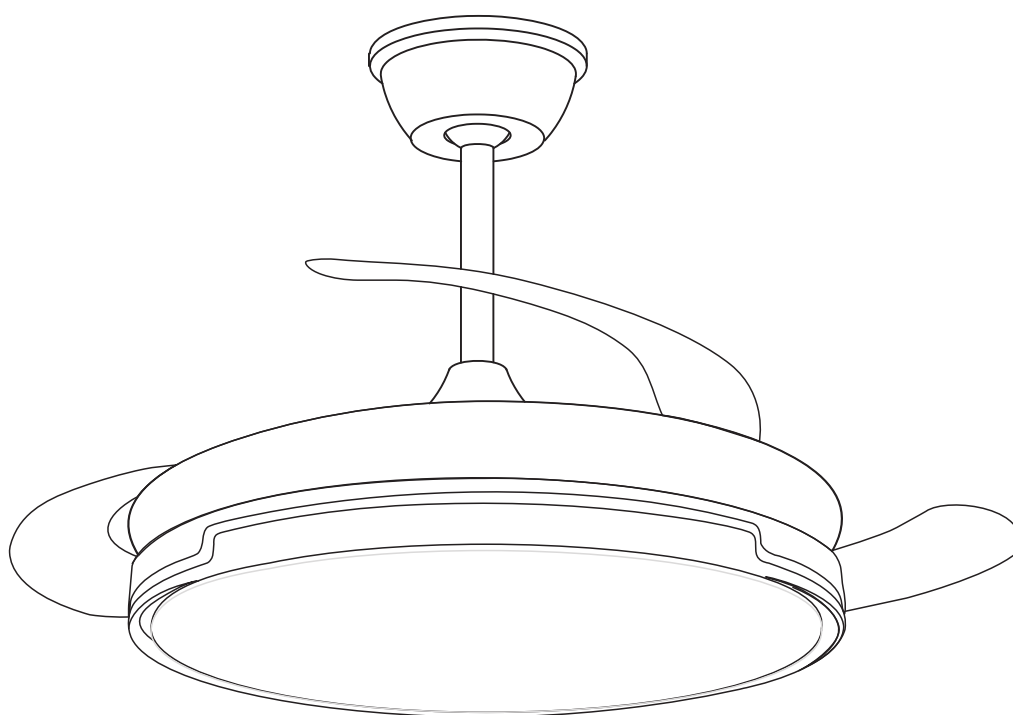

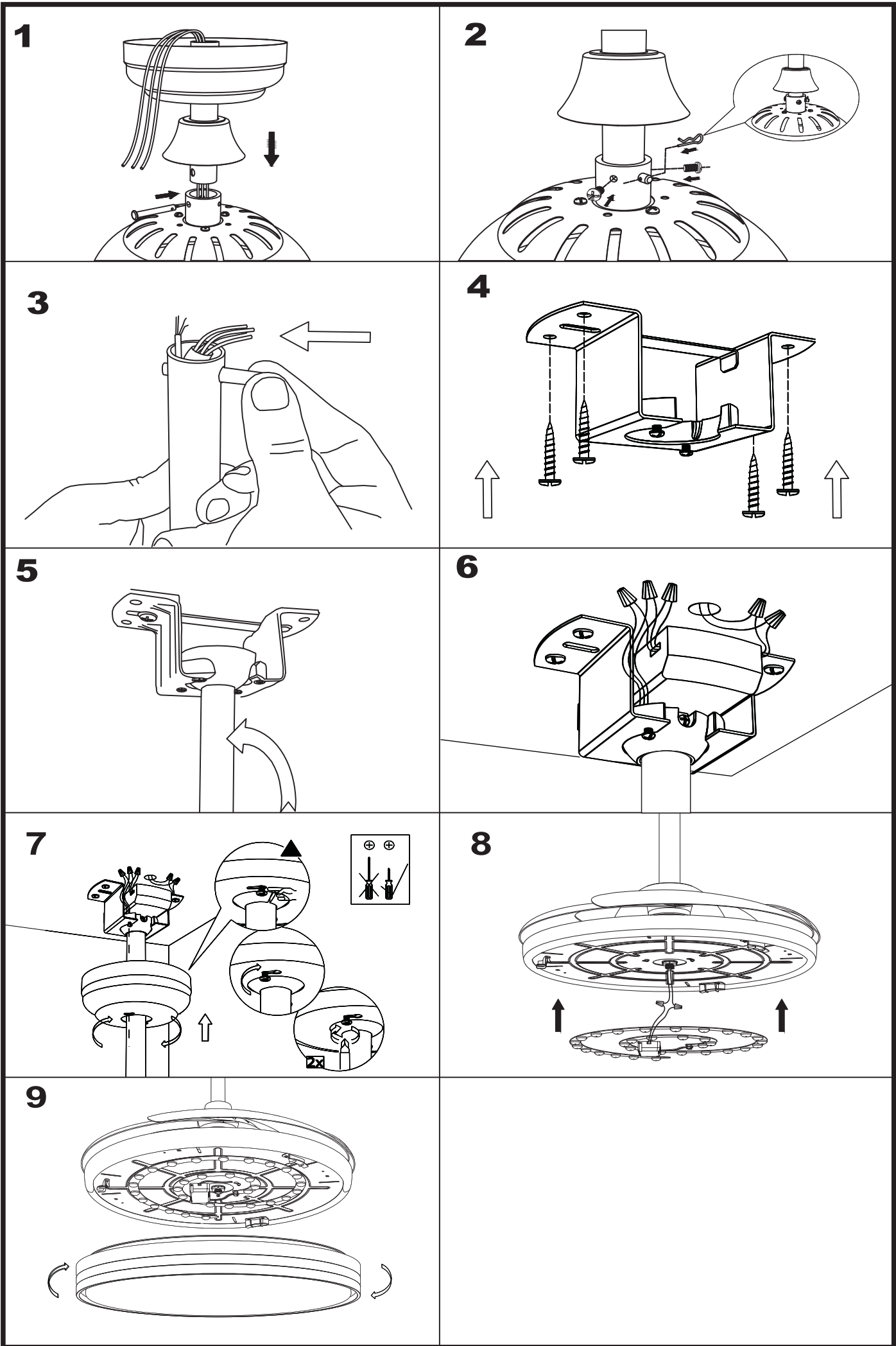

INSTRUCCIONES DEL MANDO A DISTANCIA

Instrucciones del ventilador con luz inteligente

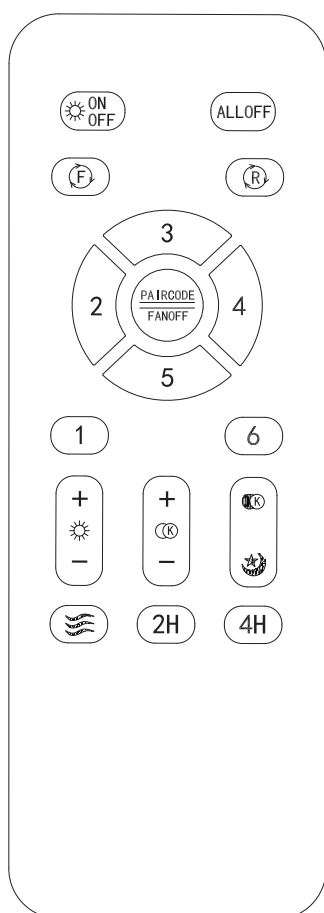

Match Code Emparejar código: Pulse "PAIR CODE" durante 3 segundos una vez que la luz esté encendida. Si la luz parpadea 2 veces, la coincidencia de código se ha realizado correctamente.
Borrado del código: Pulse "ALL OFF" durante 3 segundos una vez que la luz esté encendida.



Luz ENCENDIDA/APAGADA



Todo apagado



Interruptor de temperatura de color



Luz nocturna pequeña



Pulse o mantenga pulsado este botón para aumentar el brillo.



Pulse este botón o manténgalo pulsado para reducir el brillo.



Pulse prolongadamente este botón para aumentar la temperatura de color



Pulse prolongadamente este botón para reducir la temperatura de color



El ventilador gira hacia adelante



El ventilador gira hacia atrás



Se apaga automáticamente después de 2 horas



Se apaga automáticamente después de 4 horas



123456 Velocidad del ventilador, 1 es la más débil, 6 es la más fuerte



Viento natural



Ventilador apagado

Después de activar la función del temporizador, no pulse otras teclas del mando a distancia. Si se pulsan otras teclas, el temporizador se cancelará.

INSTRUCCIONES DEL MANDO A DISTANCIA

Asuntos que requieren atención:

1. El receptor no puede ser montado en el suelo para evitar que afecte a la irregularidad de la cubierta y el techo.
2. Las sub-entradas y salidas del receptor están estrictamente prohibidas para ajustar los parámetros de entrada y salida.
3. Si el ventilador tiene un interruptor de pared, debe estar encendido para que el control sea efectivo.
4. El cableado debe realizarse de acuerdo con el color del cable y las instrucciones del manguito.
5. Cuando utilice el mando a distancia, compruebe si la pila está instalada o no. La tecla de control del mando parpadea cada vez que se pulsa una tecla.

6. La antena debe quedar expuesta al exterior de la lámpara durante la instalación

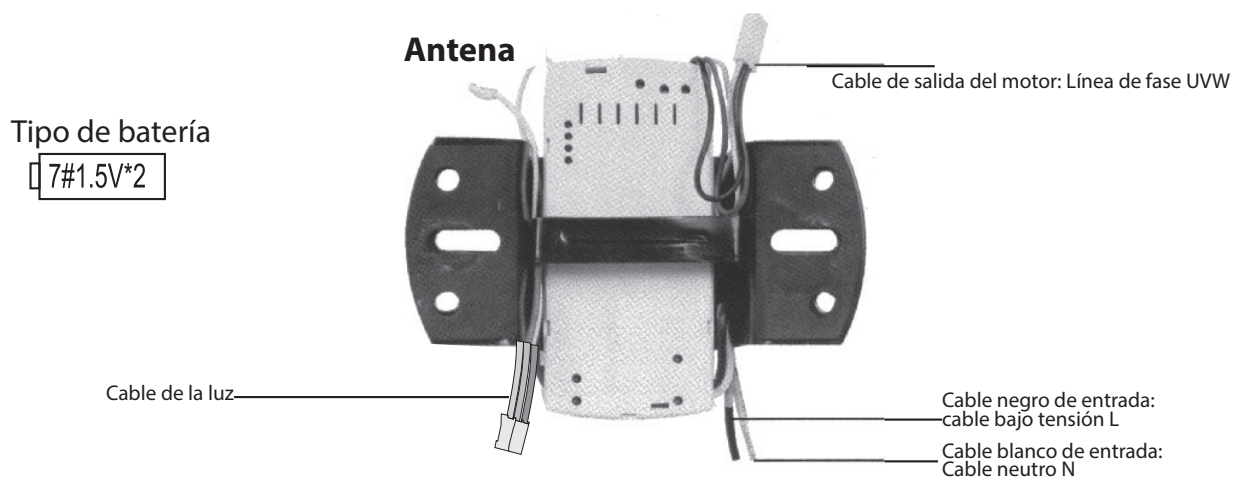







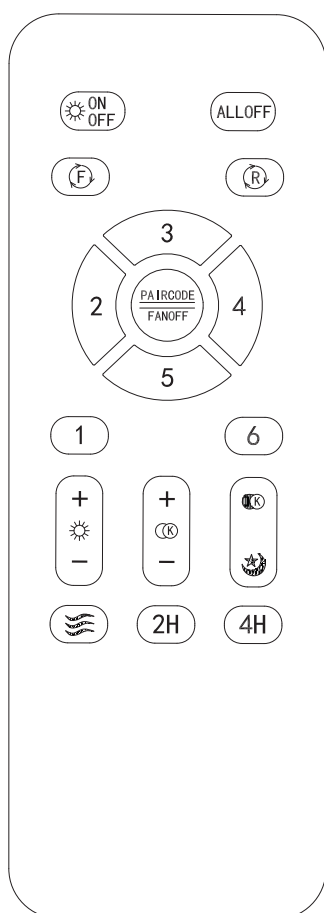







Después de activar la función del temporizador, no pulse otras teclas del mando a distancia. Si se pulsan otras teclas, el temporizador se cancelará.

REMOTE CONTROL INSTRUCTIONS

Smart fan light instructions



Match Code Code Match: Press "PAIR CODE" for 3 seconds once the light is on. If the light flashes 2 times, the code match is successful.
Clear code: Press "ALL OFF" for 3 seconds once the light is on.

-  Light ON/OFF
-  All OFF
-  Colour temperature switch
-  Small night light
-  Press or press and hold this button to increase the brightness
-  Press or press and hold this button to decrease the brightness.
-  Long press this button to increase the colour temperature. colour temperature
-  Long press this button to decrease the colour temperature
-  Fan rotates forward
-  Fan rotates backwards
-  Automatic switch off after 2 hours
-  Automatic switch off after 4 hours
-  Fan speed, 1 is weakest, 6 is strongest
-  Natural wind
-  Fan off

Do not press other buttons on the remote control after activating the timer function. If other buttons are pressed, the timer will be cancelled.

REMOTE CONTROL INSTRUCTIONS

Attention issues:

1. The receiver cannot be mounted on the ground to avoid affecting the unevenness of the roof and ceiling.
2. The sub-inputs and outputs of the receiver are strictly forbidden to adjust the input and output parameters.
3. If the fan has a wall switch, it must be turned on for the control to be effective.
4. Wiring should be in accordance with the wire colour and sleeve instructions.
5. When using the remote control, check whether the battery is installed or not. The control key on the remote control flashes every time a key is pressed.

6. The antenna must be exposed to the outside of the lamp during installation.

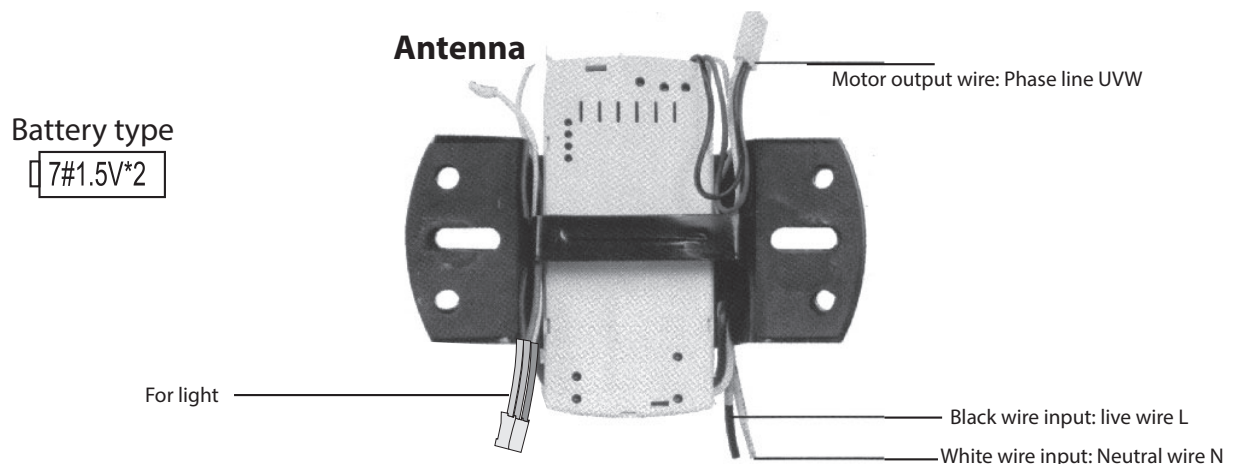

Do not press other buttons on the remote control after activating the timer function. If other buttons are pressed, the timer will be cancelled.

INSTRUÇÕES DO CONTROLO REMOTO

Instruções do ventilador com luz inteligente

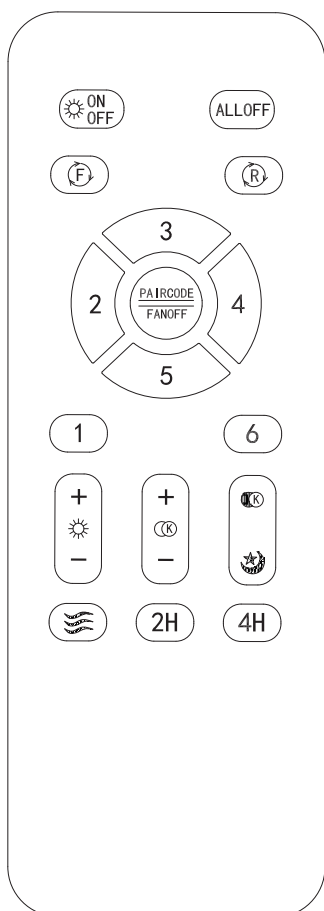

Match Code Correspondência de códigos: Prima "PAIR CODE" durante 3 segundos quando a luz estiver acesa. Se a luz piscar 2 vezes, a correspondência do código foi bem sucedida.

Apagar o código: Prima "ALL OFF" durante 3 segundos quando a luz estiver acesa.



Luz LIGADA/DESLIGADA



Tudo desligado



Interruptor da temperatura da cor



Luz noturna pequena



Prima ou mantenha premido este botão para aumentar a luminosidade.



Prima ou mantenha premido este botão para diminuir a luminosidade



Prima longamente este botão para aumentar a temperatura da cor



Premir longamente este botão para diminuir a temperatura da cor.



A ventoinha roda para a frente



A ventoinha roda para trás



Desliga-se automaticamente ao fim de 2 horas



Desligar automático após 4 horas



Velocidade da ventoinha, 1 é a mais fraca, 6 é a mais forte



Vento natural



Ventilador desligado

Após ativar a função do temporizador, não prima outras teclas do telecomando. Se forem premidas outras teclas, o temporizador será cancelado.

INSTRUÇÕES DO CONTROLO REMOTO

Questões que requerem atenção:

1. O recetor não pode ser montado no chão para não afetar os desníveis do telhado e do teto.
2. As sub-entradas e saídas do recetor são estritamente proibidas para ajustar os parâmetros de entrada e saída.
- 3) Se o ventilador tiver um interruptor de parede, este deve estar ligado para que o controlo seja eficaz.
4. A cablagem deve estar conforme a cor do fio e as instruções da manga.
5. Quando utilizar o controlo remoto, verifique se a pilha está instalada ou não. A tecla de controlo no controlo remoto pisca sempre que uma tecla é premida.

6. A antena deve ficar exposta ao exterior da lâmpada durante a instalação.

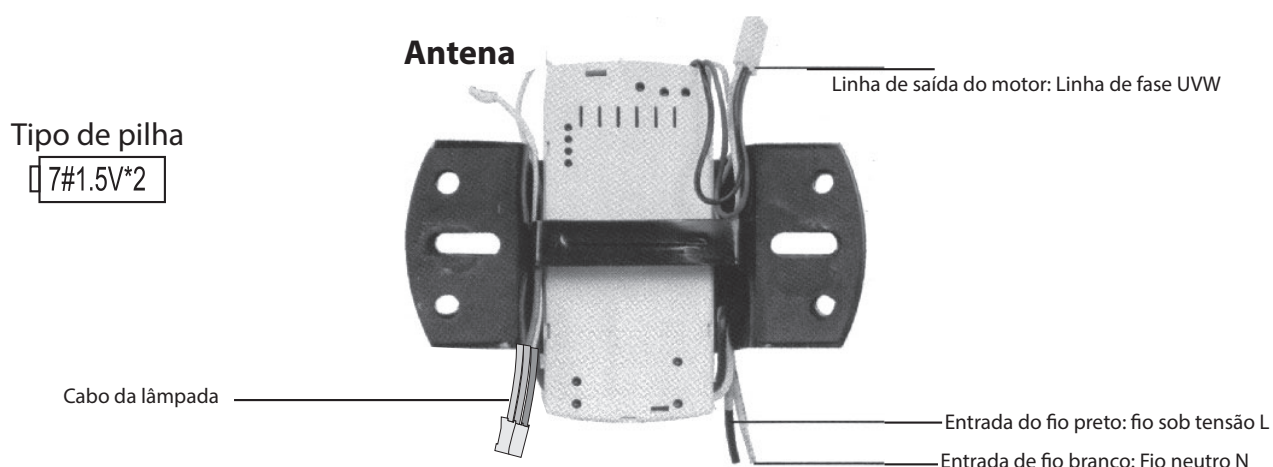

Após ativar a função do temporizador, não prima outras teclas do telecomando. Se forem premidas outras teclas, o temporizador será cancelado.

ISTRUZIONI PER IL TELECOMANDO

Istruzioni per il ventilatore intelligente

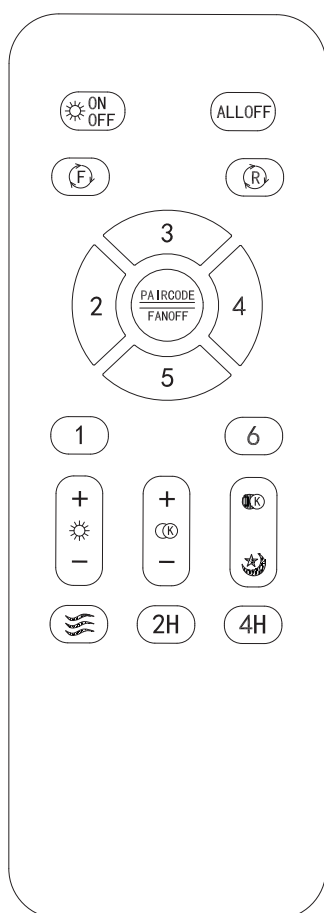

Match Code Abbinamento dei codici: premere "PAIR CODE" per 3 secondi quando la luce è accesa. Se la luce lampeggia 2 volte, la corrispondenza del codice è riuscita.

Cancellazione del codice: premere "ALL OFF" per 3 secondi quando la luce è accesa.



Luce ON/OFF



Tutto spento



Interruttore temperatura colore



Piccola luce notturna



Premere o tenere premuto questo pulsante per aumentare la luminosità



Premere o tenere premuto questo pulsante per diminuire la luminosità



Premere a lungo questo pulsante per aumentare la temperatura del colore.



Premere a lungo questo pulsante per diminuire la temperatura del colore



Il ventilatore ruota in avanti



La ventola ruota all'indietro



Si spegne automaticamente dopo 2 ore



Spegnimento automatico dopo 4 ore



Velocità della ventola, 1 è la più debole, 6 è la più forte



Vento naturale



Ventilatore spento

Dopo aver attivato la funzione timer, non premere altri tasti del telecomando. Se si premono altri tasti, il timer viene annullato.

ISTRUZIONI PER IL TELECOMANDO

Problemi che richiedono attenzione:

1. Il ricevitore non può essere montato a terra per evitare di influenzare le irregolarità del tetto e del soffitto.
2. È severamente vietato regolare i parametri di ingresso e uscita del ricevitore.
3. Se il ventilatore è dotato di un interruttore a parete, questo deve essere acceso affinché il controllo sia efficace.
4. Il cablaggio deve essere conforme alle istruzioni sui colori dei fili e sui manicotti.
5. Quando si utilizza il telecomando, verificare se la batteria è installata o meno. Il tasto di controllo sul telecomando lampeggia ogni volta che si preme un tasto.

6. Durante l'installazione, l'antenna deve essere esposta all'esterno della lampada.

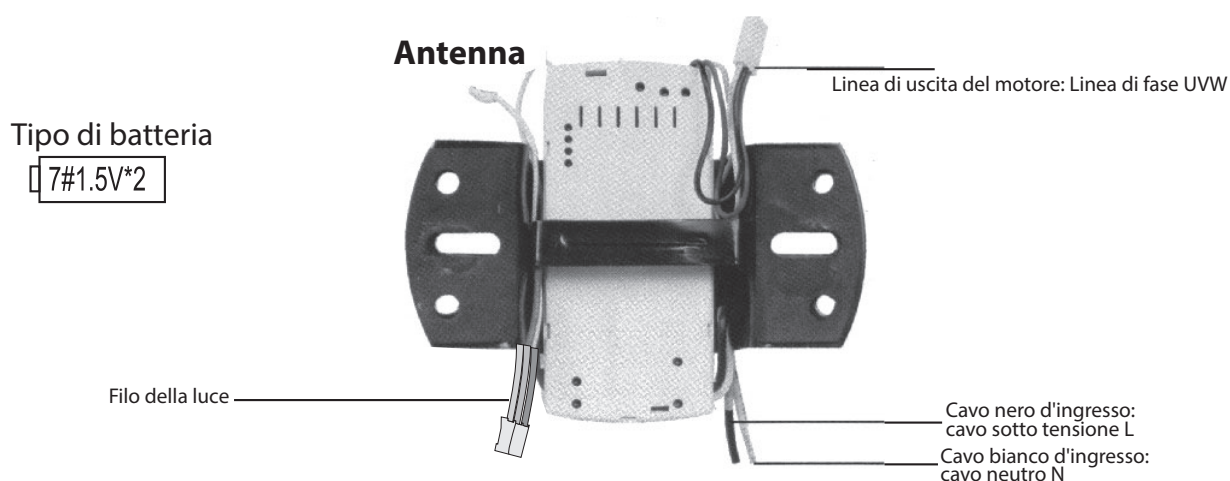

Dopo aver attivato la funzione timer, non premere altri tasti del telecomando. Se si premono altri tasti, il timer viene annullato.

INSTRUCTIONS POUR LA TÉLÉCOMMANDE

Instructions pour le ventilateur Smart Light

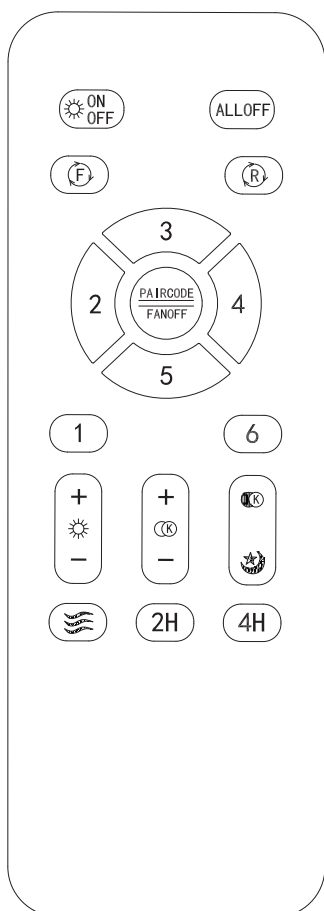

Match Code Correspondance des codes : Appuyez sur "PAIR CODE" pendant 3 secondes une fois que la lumière est allumée. Si la lumière clignote 2 fois, la correspondance des codes est réussie.

Effacement du code : Appuyez sur "ALL OFF" pendant 3 secondes une fois que la lumière est allumée.



Lumière ON/OFF



Tout est éteint



Interrupteur de température de couleur



Petite veilleuse



Appuyez ou maintenez enfoncé ce bouton pour augmenter la luminosité.



Appuyez sur ce bouton ou maintenez-le enfoncé pour diminuer la luminosité.



Appuyez longuement sur ce bouton pour augmenter la température de couleur.



Appuyez longuement sur ce bouton pour diminuer la température de couleur.



Le ventilateur tourne vers l'avant



Le ventilateur tourne vers l'arrière



Arrêt automatique après 2 heures



Arrêt automatique après 4 heures



Vitesse du ventilateur, 1 est la plus faible, 6 est la plus forte



Vent naturel



Ventilateur éteint

Après avoir activé la fonction de minuterie, n'appuyez pas sur d'autres touches de la télécommande. Si vous appuyez sur d'autres touches, la minuterie sera annulée.

INSTRUCTIONS POUR LA TÉLÉCOMMANDE

Questions nécessitant une attention particulière :

1. Le récepteur ne peut pas être installé au sol pour éviter d'affecter les irrégularités du toit et du plafond.
2. Il est strictement interdit d'utiliser les entrées et sorties secondaires du récepteur pour régler les paramètres d'entrée et de sortie.
3. Si le ventilateur est équipé d'un interrupteur mural, celui-ci doit être allumé pour que la commande soit efficace.
4. Le câblage doit être conforme aux instructions relatives à la couleur des fils et aux manchons.
5. Lors de l'utilisation de la télécommande, vérifier si la pile est installée ou non. La touche de contrôle de la télécommande clignote à chaque fois que l'on appuie sur une touche.

6. L'antenne doit être exposée à l'extérieur de la lampe lors de l'installation.

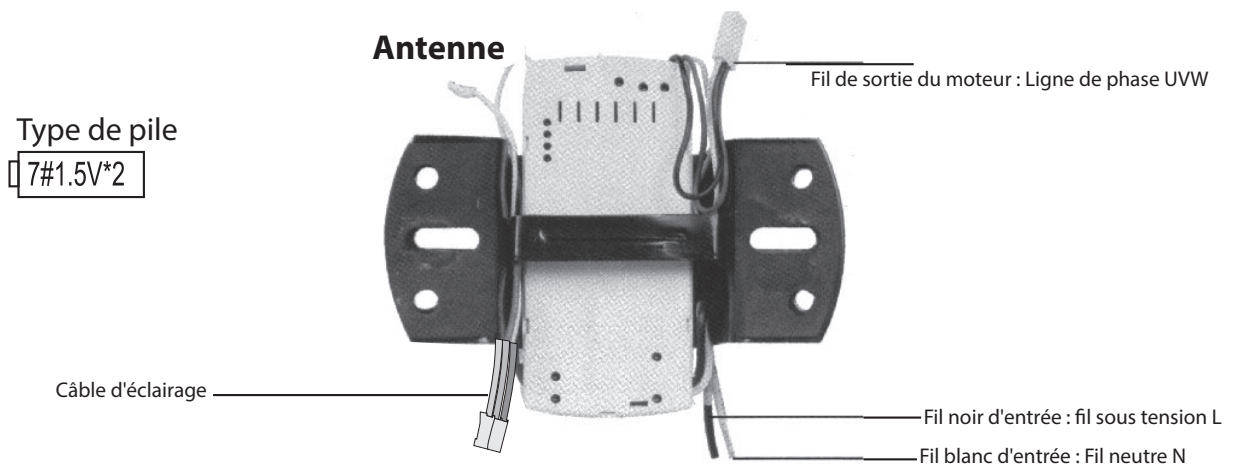

Dopo aver attivato la funzione timer, non premere altri tasti del telecomando. Se si premono altri tasti, il timer viene annullato.